

SINGER

91K6

ILLUSTRATED
LIST OF PARTS

FOR

No. 91K6 MACHINE

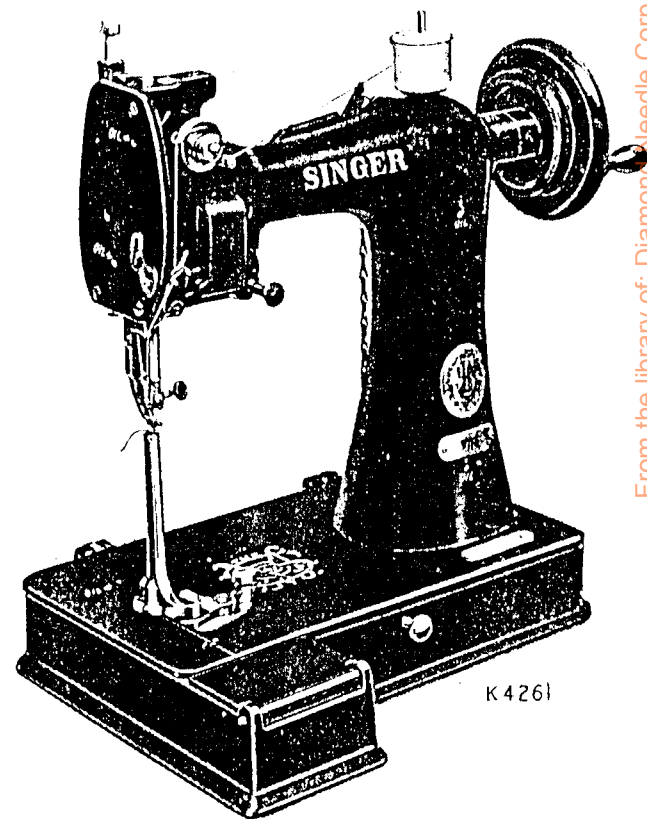

From the library of: Diamond Needle Corp

K4261

THE SINGER MANUFACTURING COMPANY

CONTENTS

Parts complete for No. 91K6 Machine	Page
							19
Accessories	24
Knee Lifter	25
Numerical List of Parts	27

From the library of: Diamond Needle Corp

25537

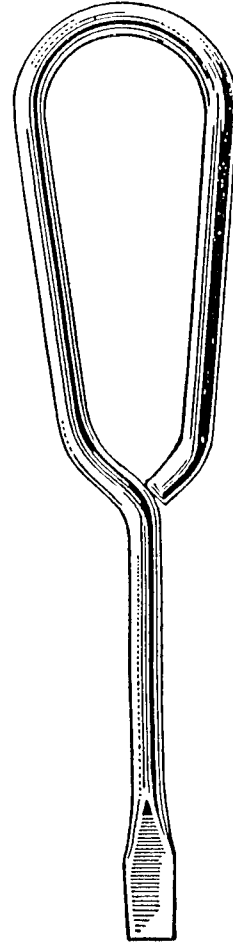

86405



36569

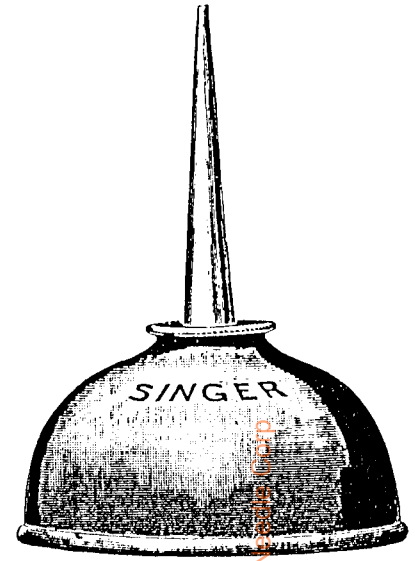

From the library of: Diamond Needle Co.

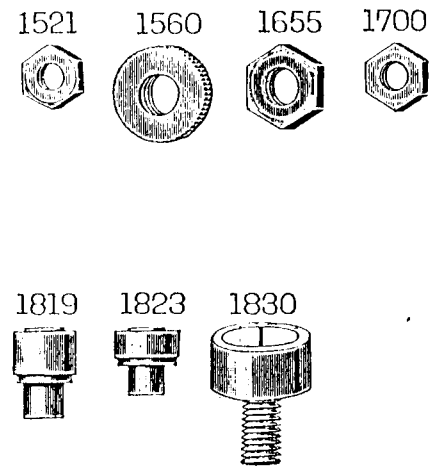
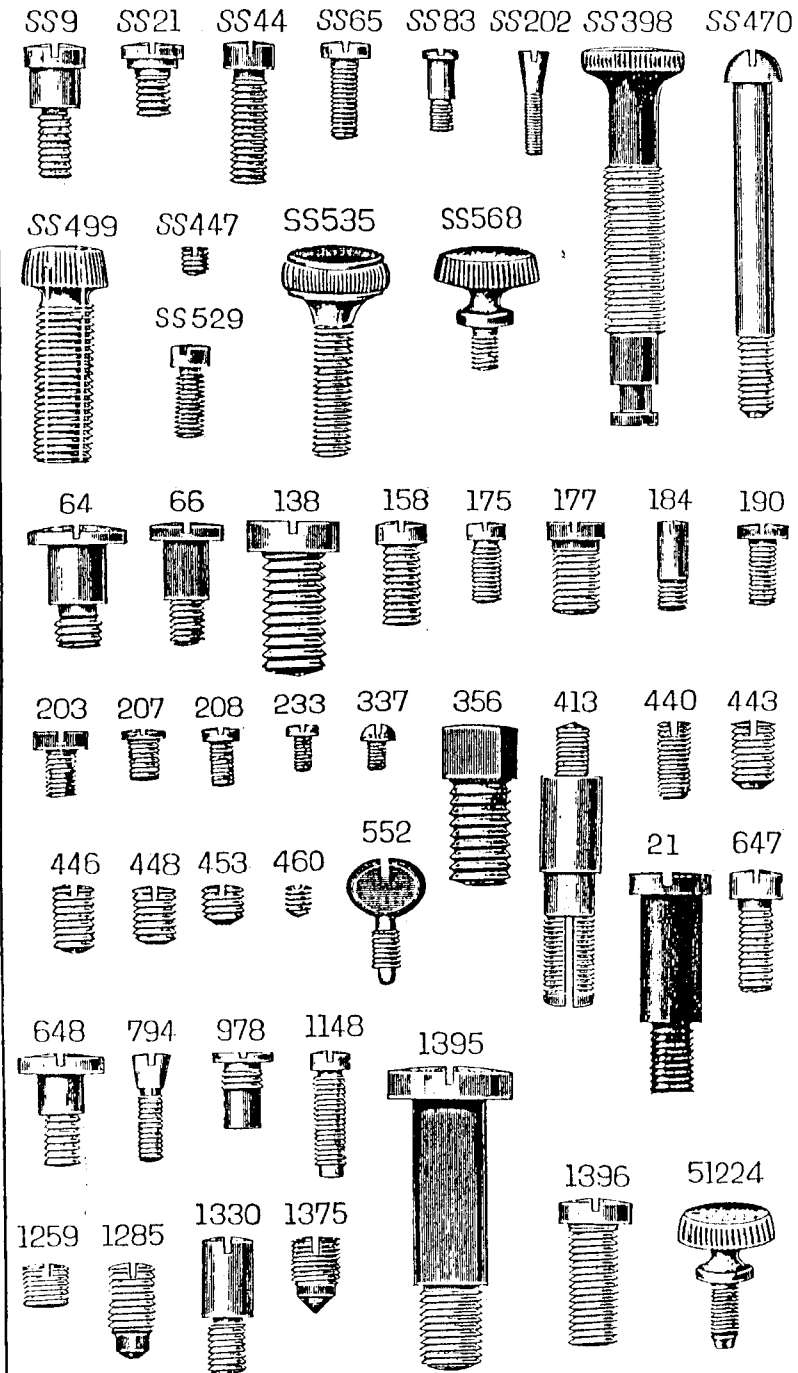

From the library of: Diamond Needle Corp

95852 95855 95935

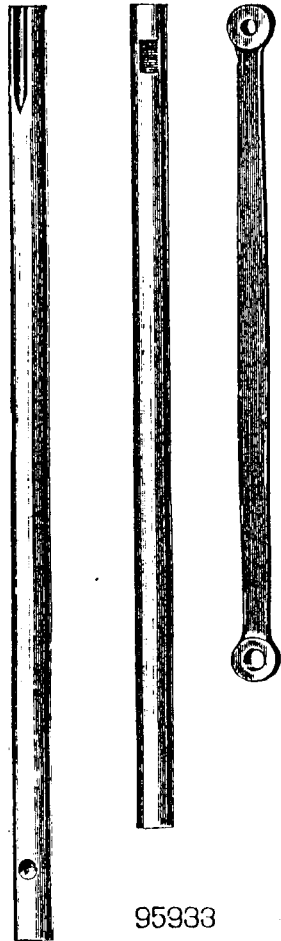

95947

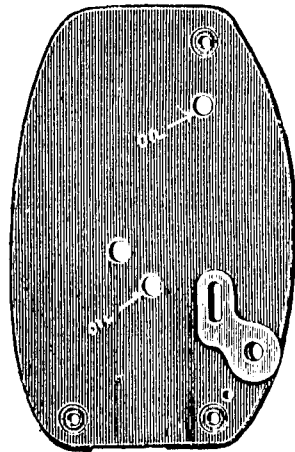

8300

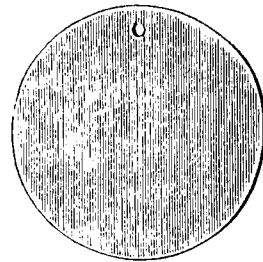

95933

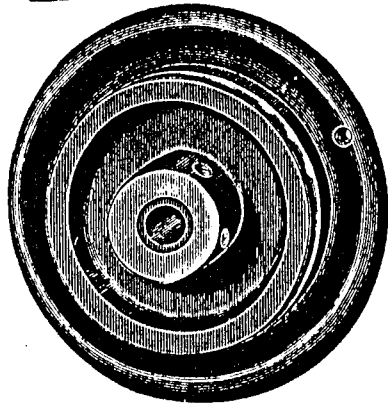

95937

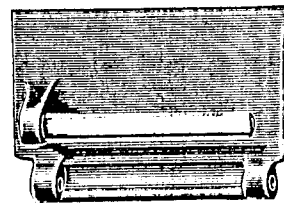

95865

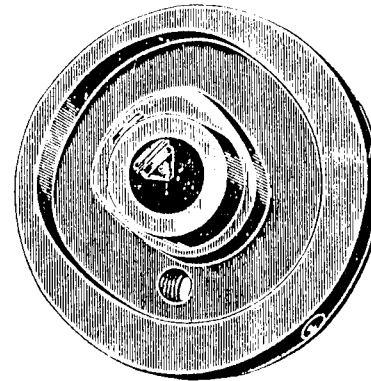

95932

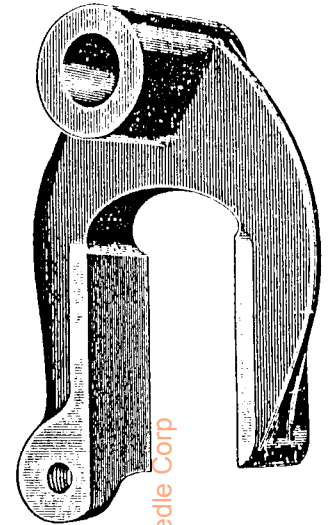

95854

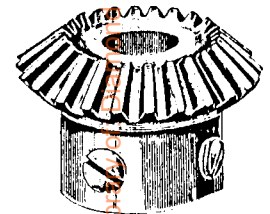

95853

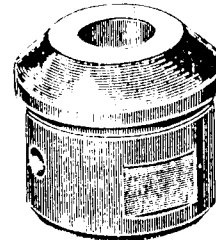

95931

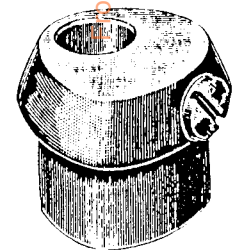

95930



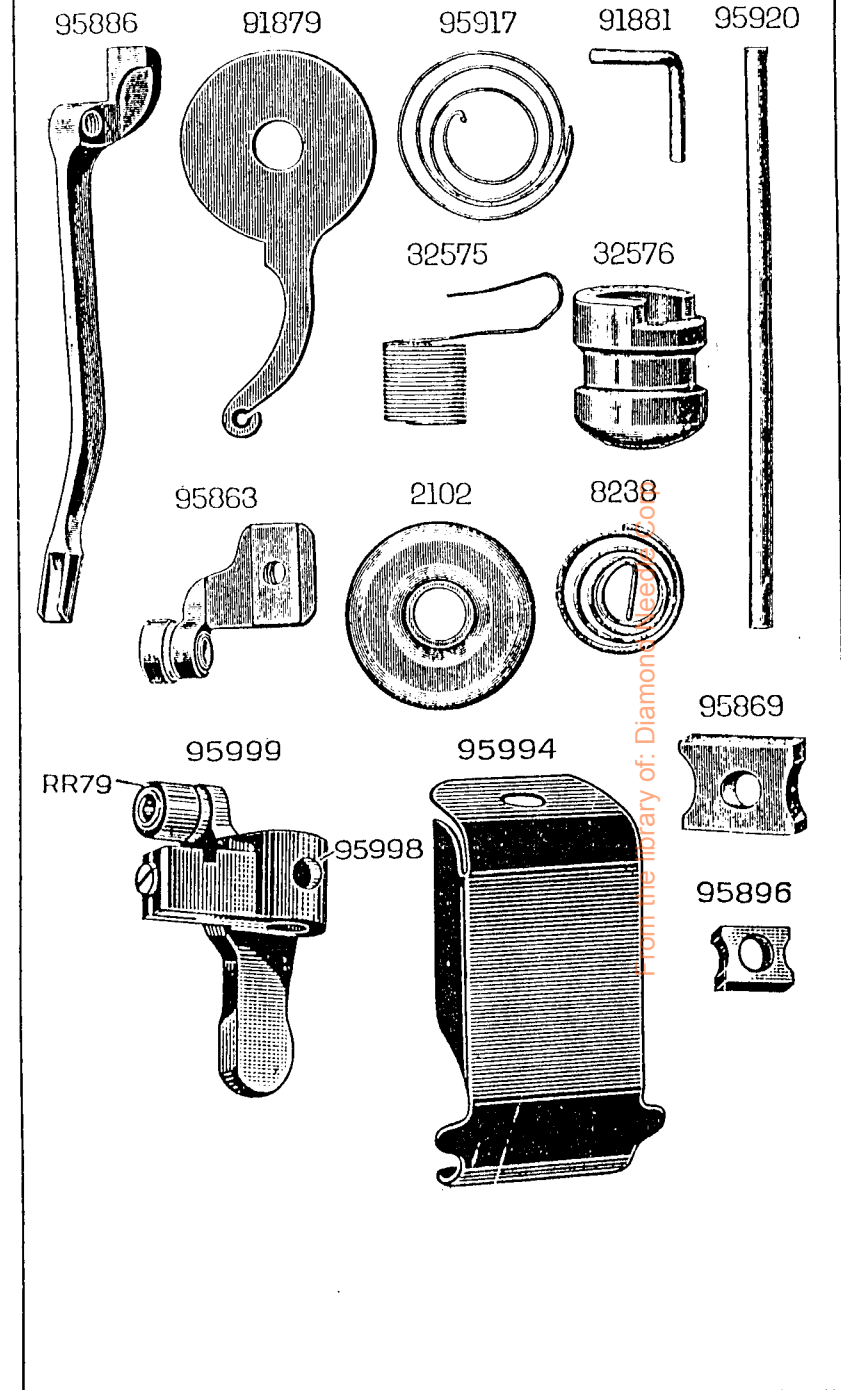
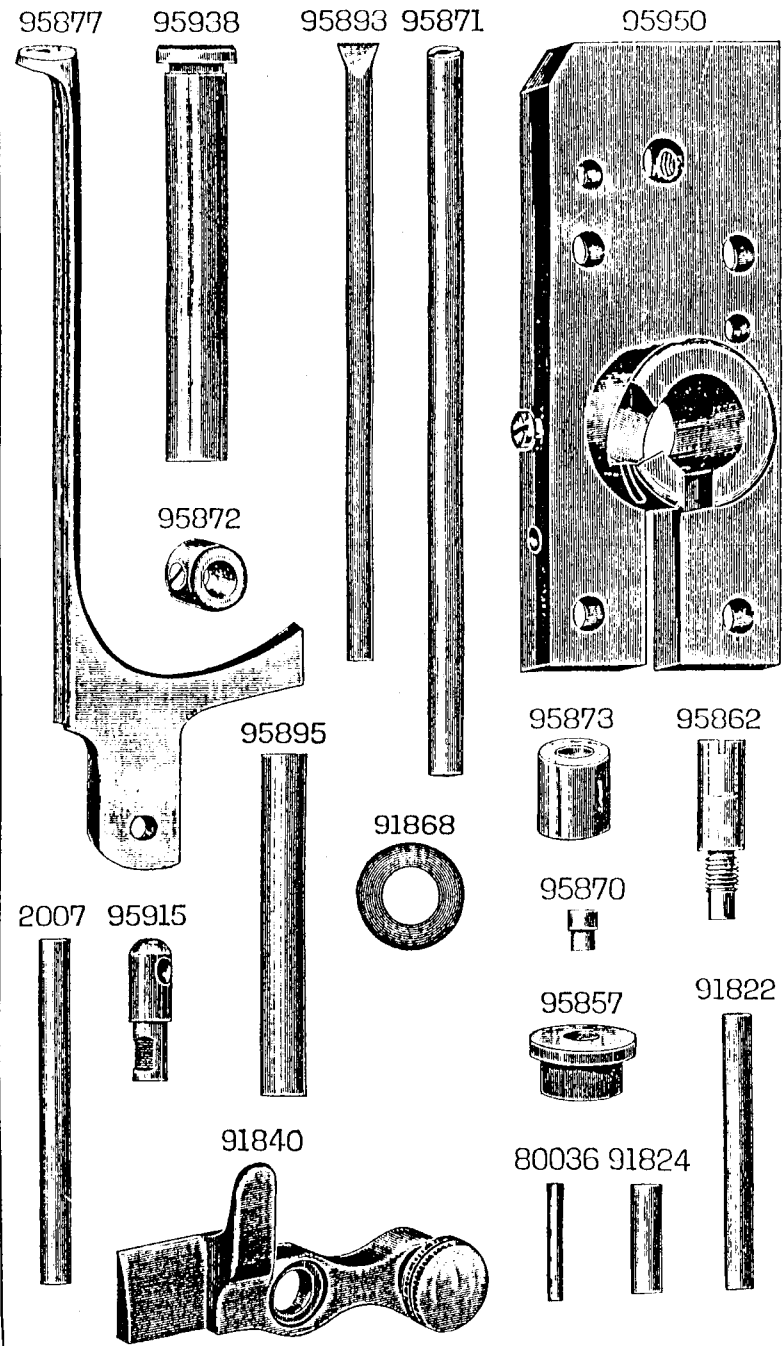

95991 SS501 95990 1159 NN94

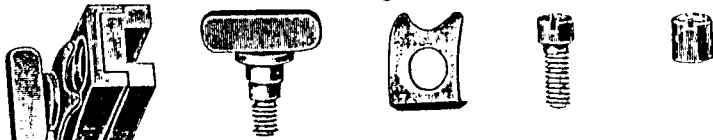

95867 95884 95885

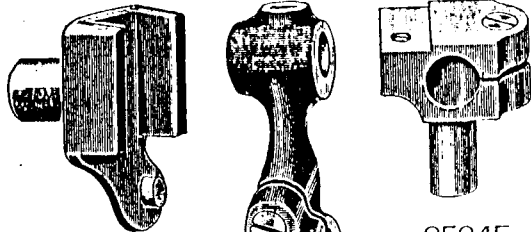

95866

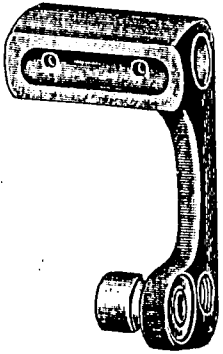

4389 2809

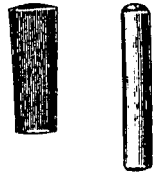

82462



95963

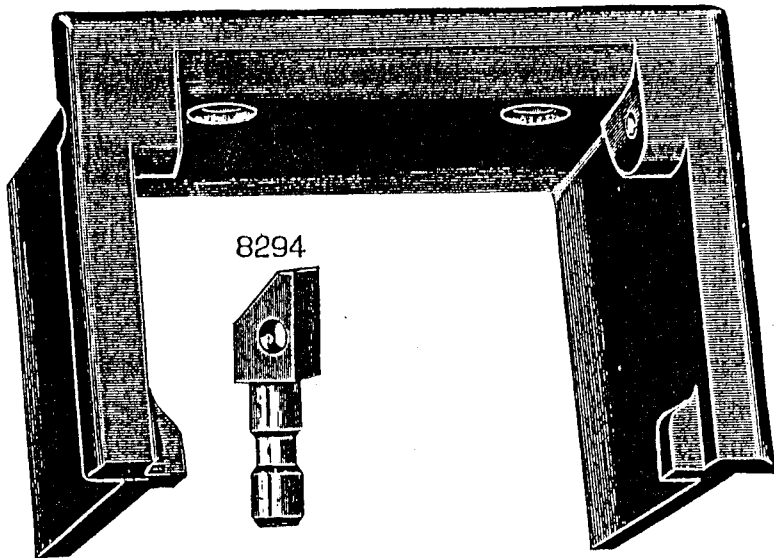

8294



95913 95981 95969 95983 95980

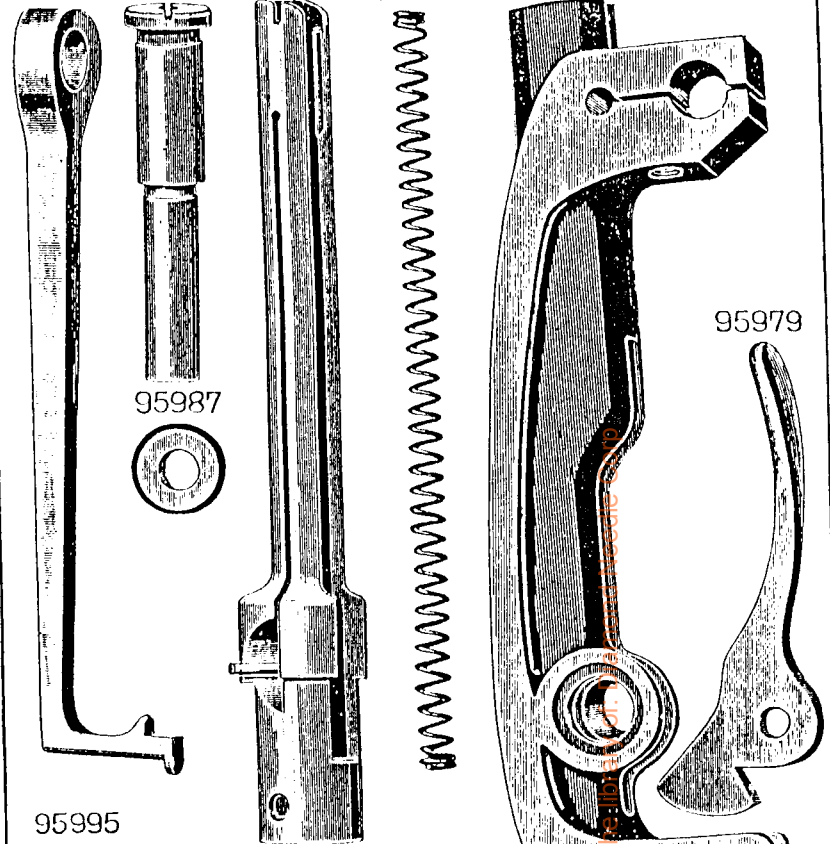

95987



95995



95985



96007



96008



95979



95975



95974



95976



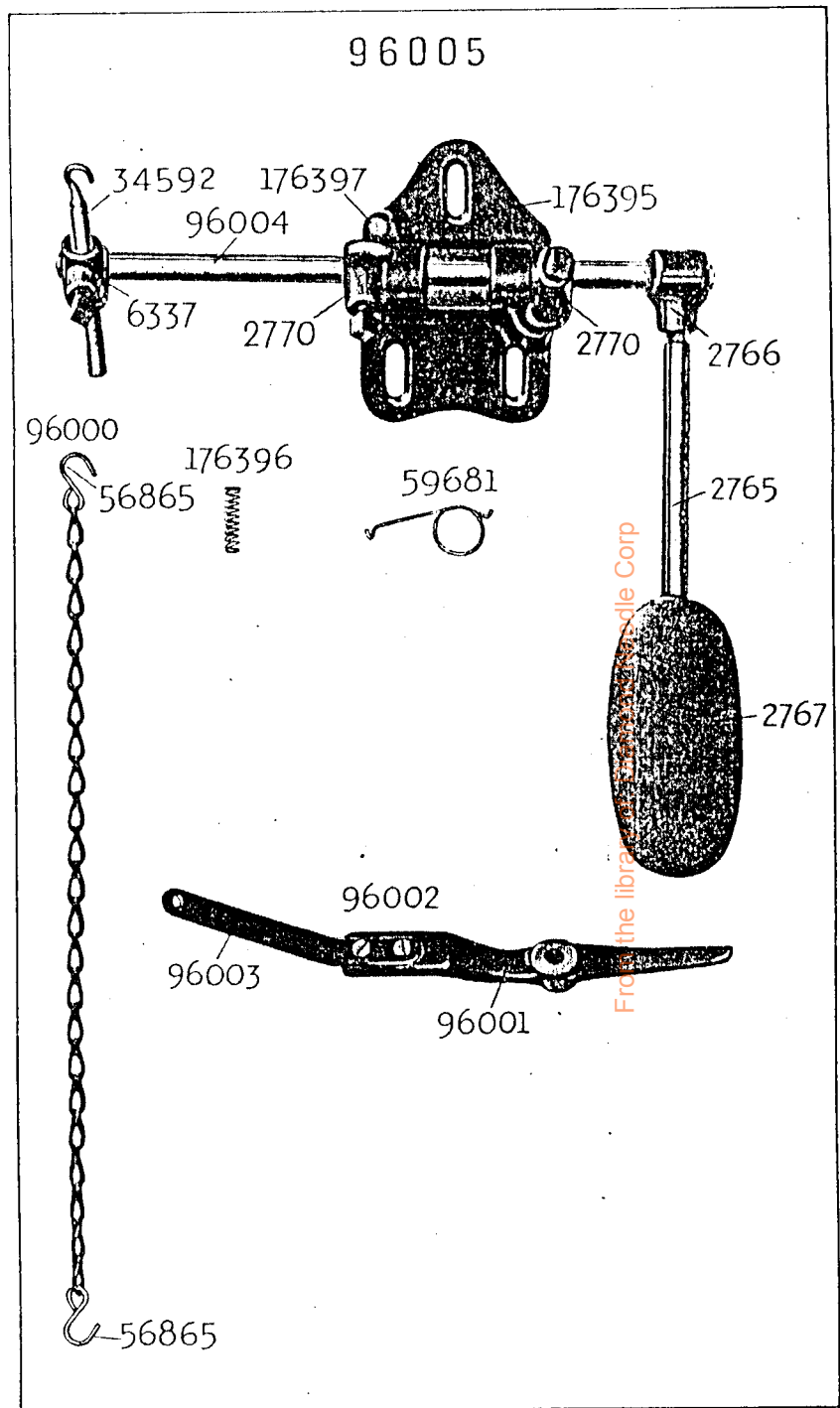
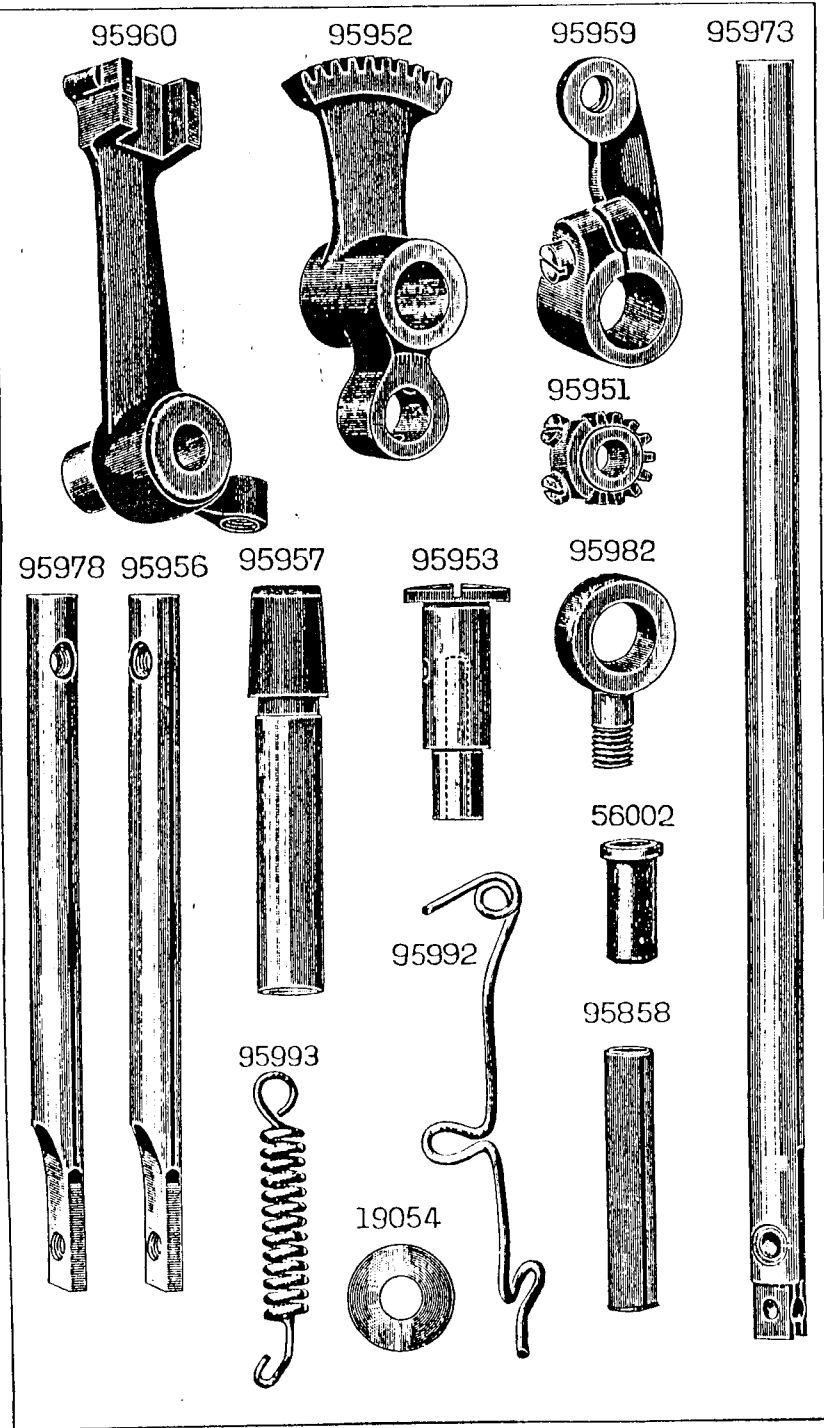

ILLUSTRATED
LIST OF PARTS
FOR
No. 91K6 Machine

From the library of: Diamond Needle Corp

INSTRUCTIONS FOR ORDERING

In ordering from this List, the prefix and affix letters with the part number **MUST BE** quoted exactly as they are shown in the first column.

A number always indicates the same part in whatever List it may appear, or for whatever machine.

The affix letters (where shown) indicate the style of finish, as follows:—

- A. Hardened, Polished, Nickel Plated and Buffed.
- A.A. Buffed and Chromium Plated.
- A.B. Hardened, Polished, Buffed and Chromium Plated.
- A.C. Brown Baking Enamel Finish.
- A.D. Grey Baking Enamel Finish.
- A.E. Hardened, Bright Rumbled and Nickel Plated.
- A.F. Hardened, Bright Rumbled and Nickel Plated, Bright Rumbled and Chromium Plated.
- A.J. Polished, Nickel Plated and Chromium Plated.
- A.K. Hardened, Polished, Nickel Plated and Chromium Plated.
- A.L. Heat Treated for Toughness.
 - B. Polished, Nickel Plated and Buffed.
 - C. Hardened only.
- C.R. Hardened and Merlized.
- D. Polished only.
- E. Soft, not Polished.
- F. Hardened and Polished.
- F.J. Hardened, Polished and Nickel Plated.
- G. Bright Rumbled and Nickel Plated.
- H. Blued.
- J. Nickel Plated only.
- K. Hardened and Nickel Plated.
- L. Brass Plated.
- M. Oxidized.
- N. Japanned, Dull.
- P. Japanned, Bright.
- P.P. Wrinkle Finish.
- R. Merlized.
- S. Cadmium Plated.
- T. Copper Plated.
- T.A. Hardened, Polished, Copper and Nickel Plated and Buffed.
- T.B. Copper and Nickel Plated and Polished.
- T.J. Copper and Nickel Plated only.
- T.K. Hardened, Copper and Nickel Plated.
- T.L. Copper and Brass Plated.
- T.M. Copper Plated and Oxidized.
 - U. Zinc Plated.
 - V. Silver Plated.
 - W. Polished and Nickel Plated.
 - X. Black Oxide for Iron and Steel.
- X.C. Hardened and Black Oxide for Iron and Steel.
 - Y. Black Nickel Plated only.
 - Z. Chromium Plated.
- Z.A. Hardened, Polished, Nickel Plated, Buffed and Chromium Plated.
- Z.B. Polished, Nickel Plated, Buffed and Chromium Plated.
- Z.C. Hardened and Chromium Plated.
- Z.D. Polished and Chromium Plated.
- Z.G. Bright Rumbled, Nickel Plated, Bright Rumbled and Chromium Plated.
- Z.J. Nickel and Chromium Plated.
- Z.T. Copper and Chromium Plated.

Parts marked with an asterisk (*) are furnished only when the repairs are made at Factory.

PARTS COMPLETE

FOR

No. 91K6 MACHINE

Has Direct Gear Driven Loper Mechanism, Adjustable Top Feed, Closed Post $\frac{5}{16}$ " diam., Knee Lifter. Makes a Double Chain Stitch (Piqué), for Glove Work.

No.	Plate				
*95997	—	Arm with 15404 and two 15405
4389	1878	" Dowel Pin (2)
95858	2504	" Oil Tube for oiling Upright Shaft Lower Bearing
56002	2504	" " " " " 05884
	138c	" Screw (3)
95852	1437	Arm Shaft (horizontal)
95853	1438	" " (") Bush (front)
	443c	" " (") " (") Set Screw
95930	1438	" " (") " (rear)
	448c	" " (") " (") Set Screw
95854	1438	" " (") Gear with two 1250c
	1259c	" " (") " Set Screw
95855	1437	" " (upright)
95931	1438	" " (") Cam with 177c
95932	1438	" " (") " Fork
	1395f	" " (") " " Hinge Screw
	177c	" " (") " Set Screw
95854	1438	" " (") Gear with two 1259c
	1259c	" " (") " Set Screw
8300p	1437	Arm Side Cover
51221d	1356	" " " Thumb Screw
2007	1439	" Spool Pin
95857	1439	" " " Bushing
95859	—	Balance Wheel (2" diam.) with 446c and 1285c
95933	1437	" " (2½" ") " 446c " 1285c
95934	—	" " (3½" ") " 446c " 1285c
NOTE.—Balance Wheel No. 95933 is supplied with this Machine unless otherwise specified on order.					
95945	1878	Balance Wheel Handle (wood)
SS470d	1356	" " " Screw Spindle
	1285c	" " Position Screw
	446c	" " Set Screw
*95966	—	Bed

From the library of: Diamond Needle Corp

No.	Plate	
95947	1437	Face Plate
190d	1356	" " Screw (3)
95802	1439	" " " Stud
95803	1441	" " Thread Nipper Bracket with 1823
SS565f	1356	" " " " " Screw
82462	1878	" " " " " Washer
1823	1357	" " " " " Roller
95805	1438	Feed Cam with 1375c
1375c	1350	" " Set Screw
95806	1878	Feed Lever with 1819
1819	1357	" " Roller
95948	—	Feed Lifting Mechanism, complete, Nos. 440f, 1521e, 1700c, 1830, 95895, 95959 and 95960
95867	1878	Feed Regulator with 95870
95869	1441	" " Slide Block
978c	1356	" " " " Hinge Screw
19054	2504	" " Spring Washer
647d	1356	" " " " Screw
95870	1439	" " Stud
SS398c	1356	" Regulating Thumb Screw
184c	1356	" " Stop Screw
95905	2503	Looper
95996	—	" 95905 with 95871
95909	2503	Looper Column with 80036
95877	1439	" " Hinged Needle Plate
91822	1439	" " " " Hinge Pin
80036	1439	" " Thread Guide Pin
95970	—	Looper Column, complete, Nos. 91822, 95872, 95873, 95877, 95950, 95951, 95969 and 95996
95950	1439	Looper Frame with 1148c
SS44c	1356	" " Binding Screw (long) (2)
158c	1356	" " " " (short) (2)
91824	1439	" " Pin (2)
95935	1437	Looper Pitman
648c	1356	" " Hinge Screw (for 95932)
66c	1356	" " " " (95952)

No.	Plate	
95871	1439	Looper Spindle
95873	1439	" " Bush
1148c	1356	" " " Set Screw
95872	1439	" " Collar with SS447c
SS447c	1356	" " " Set Screw
95951	2504	" " Pinion with two 233c
95952	2504	" " " Segment Gear
95953	2504	" " " " " Stud
1148c	1356	" " " " " Set Screw
233c	1356	" " " Set Screw
*95919	—	Looper Thread Spool Holder Plate
95920	1441	" " " " " Hinge Pin
*95936	—	" " " Pin
95937	1437	Looper Thread Spool Holder, complete, Nos. 95919 and 95936
95963	1878	Looper Thread Spool Holder Frame, for machine without Base
95964	—	Looper Thread Spool Holder and Frame, complete, Nos. 95920, 95937, 95963 and two wood screws 1/2" No. 7
<i>NOTE.—No. 95964 is supplied when Machine is ordered less Base No. 95972, and is charged extra.</i>		
95971	—	Machine Base
8294	1878	" " Hinge Connection
2809	1878	" " " " Hinge Pin
453c	1356	" " " " Set Screw (2)
SS535d	1356	" " Thumb Screw
95972	—	Machine Base, complete, Nos. SS535d, 95920, 95937, 95971, two each 2809 and 8294
95973	2504	Needle Bar
95884	1878	" " Connecting Link with 794c
794c	1356	" " " " Adjusting Screw
1330c	1356	" " " " Hinge Screw
95885	1878	" " " Stud with 175c
175c	1356	" " " " Clamping Screw
95886	1441	" " Thread Nipper
SS83c	1356	" " " " Hinge Screw
95993	2504	" " " " Spring
208c	1356	" " " " Binding Screw
95977	—	Needle Bar and Clamp, complete, Nos. 337d and 95973 to 95976
95974	2503	" Clamp with 552r
95975	2503	" " Gib
95976	2503	" " Thread Guide
337d	1356	" " " " Screw
552r	1356	" " Thumb Screw

PARTS FOR No. 91K6 MACHINE

No.	Plate				
91840	1439	Needle Plate Latch with SS568d
SS59d	1356	" " " Hinge Screw
SS568d	1356	" " " Thumb Screw
95978	2504	Presser Bar for 95985, 96007 and 96008
95056	2504	" " " 95991
<i>NOTE.—No. 95978 is sent with this machine unless otherwise specified on order.</i>					
95067	2504	Presser Bar Bushing
95998	1441	" " Guide Bracket with SS202c
95999	1441	" " " " 95998 with RR79
SS202c	1356	" " " " Adjusting Screw
RR79	1441	" " " " Roller and Stud
SS529c	1356	" " " " Set Screw
95979	2503	" " Lifter
184c	1356	" " " Hinge Screw
95950	2504	" " Lifting Cam Lever with 175c
440f	1356	" " " " Adjusting Screw
1700c	1357	" " " " " " Lock Nut
175c	1356	" " " " " Binding Screw
95994	1441	" " " " " Cover
1830	1357	" " " " " Roller and Stud
1521e	1357	" " " " " " " Lock Nut
95900	2504	" " " " " Lever
95805	1430	" " " " " Hinge Pin
460c	1356	" " " " " " " Set Screw (2)
95800	1441	" " " " " Slide Block
95980	2503	" " " " " Pendulum Bracket
95981	2503	" " " " " Feed Lever Stud
95982	2504	" " " " " " " " Yoke
1655c	1357	" " " " " " " " Nut
95987	2503	" " " " " " " " Washer
95938	1439	" " " " " Hinge Stud
1390c	1356	" " " " " " " Clamping Screw
95983	2503	" " " " " Spring
95893	1439	" " " " " Guide Wire
SS499d	1356	" " " " " Regulating Thumb Screw
95988	—	Presser Foot (angle cut teeth)
SS501f	1878	" " Adjusting Screw
95990	1878	" " " " Friction Spring
NN94c	1878	" " " " Nut
1159f	1878	" " Screw
95989	—	" " Side

PARTS FOR No. 91K6 MACHINE

No.	Plate				
95991	1878	Presser Foot (adjustable), complete, Nos. NN94c, SS501f, 1159f and 95988 to 95990
95985	2503	Presser Foot (4 serrated teeth)
96007	2503	" " (7 serrated teeth)
96008	2503	" " (pyramidal teeth)
203f	1356	" " Screw
<i>NOTE.—No. 95985 is sent with this machine unless otherwise specified on order.</i>					
95913	2503	Seam Guide
64d	1356	" " Hinge Screw
91868	1439	" " " " Spring Washer
184d	1356	" " Stop Screw
<i>NOTE.—Seam Guide No. 95913 is only supplied with this machine when specified on order and at an extra charge.</i>					
2102	1441	Tension Disc
*413c	1356	" Screw Stud
33892	—	" " " 413c with 1560d
8238	1441	" Spring
1560d	1357	" " Regulating Thumb Nut
95914	—	Tension, complete, Nos. 8238, 33892 and two 2102
95915	1439	Tension Thread Guide
460c	1356	" " " Set Screw
95992	2504	Thread Guide
207d	1356	" " Screw
91879	1441	Thread Take-down
SS21d	1356	" " Hinge Screw
95917	1441	" " Spring
91881	1441	" " Stop Pin
175d	1356	" " " " Screw
32575	1441	Thread Take-up Spring
32576	1441	" " " Regulator
453c	1356	" " " " Set Screw
*15404	—	Trade Mark
15405	—	" " Rivet

From the library of: Diamond Needle Corp

ACCESSORIES

No.	Plate	
—	—	Instruction Book
46x1	—	Needles (two each sizes 7, 8 and 9)
36569	1355	Oiler
25537	1355	Screw Driver
86405	1355	Tweezers
—	—	Wood Screws $1\frac{1}{4}'' \times \frac{1}{4}''$ (2)

KNEE LIFTER

(Supplied with machine)

No.	Plate	
96000	2505	Chain (22 links) with two 56865
56865	2505	" Hook
96001	2505	Lifting Lever
96002	2505	" " 96001 with 96003 and two 190j
96003	2505	" " Extension
190j	1356	" " " Screw
21d	1356	" " Hinge Screw
59681	2505	" " Spring
96004	2505	Rock Shaft
176395	2505	" " Hinge Bracket with 176397
2765	2505	" " Knee Arm
2768	—	" " " " 2765 with 2766 and 2767
2766	2505	" " " " Hub with 356c
356c	1356	" " " " Set Screw
2767	2505	" " " " Plate with 356c
356c	1356	" " " " Set Screw
6337	2505	" " Operating Bracket with two 356c
34592	2505	" " " " Hook
356c	1356	" " " " Set Screw
356c	1356	" " " " Set Screw
176396	2505	" " Spring
176397	2505	" " Stop (leather)
2770	2505	" " " Dog with 356c
356c	1356	" " " " Set Screw
96005	2505	Rock Shaft, complete, Nos. 2768, 6337, 34592, 96004, 176395, 176396 and two 2770
96006	—	Knee Lifter, complete, Nos. 21d, 59681, 96000, 96002 and 96005

From the library of: Diamond Needle Corp

NUMERICAL LIST OF PARTS

No.	Plate	
SS9d	1356	Needle Plate Latch Hinge Screw
21d	1356	Knee Lifter Lifting Lever Hinge Screw for 96006
SS21d	1356	Thread Take-down Hinge Screw
SS44c	1356	Looper Frame Binding Screw (long)
64d	1356	Seam Guide Hinge Screw
SS65f	1356	Face Plate Thread Nipper Bracket Screw
66c	1356	Looper Pitman Hinge Screw for 05952
RR79	1441	Presser Bar Guide Bracket Roller and Stud for 95909
SS83c	1356	Needle Bar Thread Nipper Hinge Screw
NN94c	1878	Presser Foot Adjusting Screw Nut for 95991
138e	1356	Arm Screw
158c	1356	Looper Frame Binding Screw (short)
175c	1356	Needle Bar Connecting Stud Clamping Screw for 95885
175c	1356	Presser Bar Lifting Cam Lever Binding Screw for 95059
175d	1356	Thread Take-down Stop Pin Screw
177c	1356	Arm Shaft (upright) Cam Set Screw for 95991
184c	1356	Feed Regulating Stop Screw
184c	1356	Presser Bar Lifter Hinge Screw
184d	1356	Seam Guide Stop Screw
190d	1356	Face Plate Screw
190j	1356	Knee Lifter Lifting Lever Extension Screw for 96002
SS202c	1356	Presser Bar Guide Bracket Adjusting Screw for 95958
203f	1356	Presser Foot Screw for 95985
207d	1356	Thread Guide Screw
208c	1356	Needle Bar Thread Nipper Spring Binding Screw
233c	1356	Looper Spindle Pinion Set Screw for 95951
337d	1356	Needle Clamp Thread Guide Screw for 95977
356c	1356	Knee Lifter Rock Shaft Knee Arm Hub Set Screw for 2760
356c	1356	Knee Lifter Rock Shaft Knee Plate Set Screw for 2767
356c	1356	Knee Lifter Rock Shaft Operating Bracket Hook Set Screw for 6337
356c	1356	Knee Lifter Rock Shaft Operating Bracket Set Screw for 6337
356c	1356	Knee Lifter Rock Shaft Stop Dog Set Screw for 2770

From the library of: Dianod Needle Corp

No.	Plate	Description
SS398c	1356	Feed Regulating Thumb Screw ...
*413c	1356	Tension Screw Stud for 33892 ...
440f	1356	Presser Bar Lifting Cam Lever Adjusting Screw for 95948 ...
443c	1356	Arm Shaft (horizontal) Bush (front) Set Screw
446c	1356	Balance Wheel Set Screw for 95859, 95933 and 95934 ...
SS447c	1356	Looper Spindle Collar Set Screw for 95872 ...
448c	1356	Arm Shaft (horizontal) Bush (rear) Set Screw
453c	1356	Machine Base Hinge Connection Set Screw
453c	1356	Thread Take-up Spring Regulator Set Screw
400c	1356	Presser Bar Lifting Lever Hinge Pin Set Screw ...
400c	1356	Tension Thread Guide Set Screw ...
SS470d	1356	Balance Wheel Handle Screw Spindle ...
SS490d	1356	Presser Bar Spring Regulating Thumb Screw
SS501f	1878	Presser Foot Adjusting Screw for 95991 ...
SS520c	1356	Presser Bar Guide Bracket Set Screw ...
SS535d	1356	Machine Base Thumb Screw for 95972 ...
552r	1356	Needle Clamp Thumb Screw for 95974 ...
SS568d	1356	Needle Plate Latch Thumb Screw for 91840
647d	1356	Feed Regulator Spring Washer Screw ...
648c	1356	Looper Pitman Hinge Screw for 95932 ...
794c	1356	Needle Bar Connecting Link Adjusting Screw for 95884 ...
978c	1356	Feed Regulator Slide Block Hinge Screw
1148c	1356	Looper Spindle Bush Set Screw for 95950 ...
1148c	1356	Looper Spindle Pinion Segment Gear Stud Set Screw ...
1159f	1878	Presser Foot Screw for 95991 ...
1259c	1356	Arm Shaft (horizontal) Gear Set Screw for 95854 ...
1259c	1356	Arm Shaft (upright) Gear Set Screw for 95854
1285c	1356	Balance Wheel Position Screw for 95859, 95933 and 95934 ...
1330c	1356	Needle Bar Connecting Link Hinge Screw
1375c	1356	Feed Cam Set Screw for 95805 ...
1305f	1356	Arm Shaft (upright) Cam Fork Hinge Screw
1390c	1356	Presser Bar Pendulum Bracket Hinge Stud Clamping Screw ...
1521e	1357	Presser Bar Lifting Cam Lever Roller and Stud Lock Nut for 95948 ...
1560d	1357	Tension Spring Regulating Thumb Nut for 33892 ...
1055c	1357	Presser Bar Pendulum Bracket Feed Lever Stud Yoke Nut ...

No.	Plate	Description
1700c	1357	Presser Bar Lifting Cam Lever Adjusting Screw Lock Nut for 95948 ...
1819	1357	Feed Lever Roller for 95866 ...
1823	1357	Face Plate Thread Nipper Roller for 95863 ...
1830	1357	Presser Bar Lifting Cam Lever Roller and Stud for 95948 ...
2007	1439	Arm Spool Pin ...
2102	1441	Tension Disc for 95914 ...
2765	2505	Knee Lifter Rock Shaft Knee Arm for 2768
2766	2505	Knee Lifter Rock Shaft Knee Arm Hub with 356c, for 2768 ...
2767	2505	Knee Lifter Rock Shaft Knee Plate with 356c, for 2768 ...
2768	—	Knee Lifter Rock Shaft Knee Arm 2705 with 2766 and 2767, for 96005 ...
2770	2505	Knee Lifter Rock Shaft Stop Dog with 356c, for 96005 ...
2809	1878	Machine Base Hinge Connection Hinge Pin for 95972 ...
4389	1878	Arm Dowel Pin ...
6337	2505	Knee Lifter Rock Shaft Operating Bracket with two 356c, for 96005 ...
8238	1441	Tension Spring for 95914 ...
8294	1878	Machine Base Hinge Connection for 95972 ...
8300p	1437	Arm Side Cover ...
*15404	—	Trade Mark for 95997 ...
15405	—	Trade Mark Rivet for 95997 ...
19054	2504	Feed Regulator Spring Washer ...
25537	1355	Screw Driver ... (Accessories)
32575	1441	Thread Take-up Spring ...
32576	1441	Thread Take-up Spring Regulator ...
33892	—	Tension Screw Stud 413c with 1560d, for 95914 ...
34592	2505	Knee Lifter Rock Shaft Operating Bracket Hook for 96005 ...
30569	1355	Oiler ... (Accessories)
51224d	1356	Arm Side Cover Thumb Screw ...
56002	2504	Arm Oil Tube, for oiling 95884 ...
56865	2505	Knee Lifter Chain Hook for 96000 ...
59681	2505	Knee Lifter Lifting Lever Spring for 96000
80036	1439	Looper Column Thread Guide Pin for 95969
82462	1878	Face Plate Thread Nipper Bracket Screw Washer ...
80405	1355	Tweezers ... (Accessories)
91822	1439	Looper Column Hinged Needle Plate Hinge Pin for 95970 ...
91824	1439	Looper Frame Pin ...

No.	Plate	
91840	1439	Needle Plate Latch with SS568d ...
91868	1439	Seam Guide Hinge Screw Spring Washer ...
91879	1441	Thread Take-down ...
91881	1441	Thread Take-down Stop Pin ...
95852	1437	Arm Shaft (horizontal) ...
95853	1438	Arm Shaft (horizontal) Bush (front) ...
95854	1438	Arm Shaft (horizontal) Gear with two 1259c ...
95854	1438	Arm Shaft (upright) Gear with two 1259c ...
95855	1437	Arm Shaft (upright) ...
95857	1439	Arm Spool Pin Bushing ...
95858	2504	Arm Oil Tube, for oiling Upright Shaft Lower Bearing ...
95859	—	Balance Wheel (2" diam.) with 446c and 1285c ...
95862	1439	Face Plate Screw Stud ...
95863	1441	Face Plate Thread Nipper Bracket with 1823 ...
95865	1438	Feed Cam with 1375c ...
95866	1878	Feed Lever with 1819 ...
95867	1878	Feed Regulator with 95870 ...
95869	1441	Feed Regulator Slide Block ...
95870	1439	Feed Regulator Stud for 95867 ...
95871	1439	Looper Spindle for 95996 ...
95872	1439	Looper Spindle Collar with SS447c for 95970 ...
95873	1439	Looper Spindle Bush for 95970 ...
95877	1439	Looper Column Hinged Needle Plate for 95970 ...
95884	1878	Needle Bar Connecting Link with 794c ...
95885	1878	Needle Bar Connecting Stud with 175c ...
95886	1441	Needle Bar Thread Nipper ...
95893	1439	Presser Bar Spring Guide Wire ...
95895	1439	Presser Bar Lifting Lever Hinge Pin for 95948 ...
95896	1441	Presser Bar Lifting Lever Slide Block ...
95913	2503	Seam Guide ...
95914	—	Tension, complete, Nos. 8238, 33892 and two 2102 ...
95915	1439	Tension Thread Guide ...
95917	1441	Thread Take-down Spring ...
*95919	—	Looper Thread Spool Holder Plate for 95937 ...
95920	1441	Looper Thread Spool Holder Plate Hinge Pin for 95964 and 95972 ...
95930	1438	Arm Shaft (horizontal) Bush (rear) ...
95931	1438	Arm Shaft (upright) Cam with 177c ...
95932	1438	Arm Shaft (upright) Cam Fork ...
95933	1437	Balance Wheel (2½" diam.) with 446c and 1285c ...
95934	—	Balance Wheel (3½" diam.) with 446c and 1285c ...
95935	1437	Looper Pitman ...

No.	Plate	
*95936	—	Looper Thread Spool Pin for 95937 ...
95937	1437	Looper Thread Spool Holder, complete, Nos. 95919 and 95936 for 95964 and 95972 ...
95938	1439	Presser Bar Pendulum Bracket Hinge Stud ...
95945	1878	Balance Wheel Handle (wood) ...
95947	1437	Face Plate ...
95948	—	Feed Lifting Mechanism, complete, Nos. 440f, 1521e, 1700c, 1830, 95895, 95959 and 95960 ...
95950	1439	Looper Frame with 1148c, for 95970 ...
95951	2504	Looper Spindle Pinion with two 233c for 95970 ...
95952	2504	Looper Spindle Pinion Segment Gear ...
95953	2504	Looper Spindle Pinion Segment Gear Stud ...
95956	2504	Presser Bar for 95991 ...
95957	2504	Presser Bar Bushing ...
95959	2504	Presser Bar Lifting Cam Lever with 175c for 95948 ...
95960	2504	Presser Bar Lifting Lever for 95948 ...
95963	1878	Looper Thread Spool Holder Frame, for machine without Base, for 95964 ...
95964	—	Looper Thread Spool Holder and Frame complete, Nos. 95920, 95937, 95963 and two wood screws ¼" No. 7 ...

NOTE.—No. 95964 is supplied when machine is ordered less Base No. 95972, and is charged extra.

*95966	—	Bed ...
95969	2503	Looper Column with 80036 for 95970 ...
95970	—	Looper Column, complete, Nos. 91822, 95872, 95873, 95877, 95950, 95951, 95969 and 95996 ...
95971	—	Machine Base for 95972 ...
95972	—	Machine Base, complete, Nos. SS535d, 95920, 95937, 95971, two each 2809 and 8294 ...
95973	2504	Needle Bar for 95977 ...
95974	2503	Needle Clamp with 552r for 95977 ...
95975	2503	Needle Clamp Gib for 95977 ...
95976	2503	Needle Clamp Thread Guide for 95977 ...
95977	—	Needle Bar and Clamp, complete, Nos. 337d and 95973 to 95976 ...
95978	2504	Presser Bar for 95985, 96007 and 96008 ...
95979	2503	Presser Bar Lifter ...
95980	2503	Presser Bar Pendulum Bracket ...
95981	2503	Presser Bar Pendulum Bracket Feed Lever Stud ...
95982	2504	Presser Bar Pendulum Bracket Feed Lever Stud Yoke ...

NUMERICAL LIST OF PARTS

No.	Plate	
95983	2503	Presser Bar Spring
95985	2503	Presser Foot (4 serrated teeth)
95987	2503	Presser Bar Pendulum Bracket Feed Lever Stud Yoke Nut Washer
95988	—	Presser Foot (angle cut teeth) for 95991
95989	—	Presser Foot Side for 95991
95990	1878	Presser Foot Adjusting Screw Friction Spring for 95991
95991	1878	Presser Foot (Adjustable), complete, Nos. NN94c, SS501f, 1159f and 95988 to 95990
95992	2504	Thread Guide
95993	2504	Needle Bar Thread Nipper Spring
95994	1441	Presser Bar Lifting Cam Lever Cover
95995	2503	Looper for 95996
95996	—	Looper 95995, with 95871, for 95970
95997	—	Arm with 15404 and two 15405
95998	1441	Presser Bar Guide Bracket with SS202c
95999	1441	Presser Bar Guide Bracket 95998, with RR79
96000	2505	Knee Lifter Chain (22 links) with two 56865, for 96006
96001	2505	Knee Lifter Lifting Lever for 96002
96002	2505	Knee Lifter Lifting Lever 96001, with 96003 and two 190j, for 96006
96003	2505	Knee Lifter Lifting Lever Extension for 96002
96004	2505	Knee Lifter Rock Shaft for 96005
96005	2505	Knee Lifter Rock Shaft, complete, Nos. 2768, 8337, 34592, 96004, 176395, 176396 and two 2770, for 96006
96006	—	Knee Lifter, complete, Nos. 21d, 59681, 96000, 96002 and 96005
96007	2503	Presser Foot (7 serrated teeth)
96008	2503	Presser Foot (pyramidal teeth)

NUMERICAL LIST OF PARTS

No.	Plate	
176395	2505	Knee Lifter Rock Shaft Hinge Bracket with 176397, for 96005
176396	2505	Knee Lifter Rock Shaft Spring for 96005
176397	2505	Knee Lifter Rock Shaft Stop (leather) for 176395

From the library of: Diamond Needle Corp